



JO
DE GROOT
TERRASADVIES

JCP.6 SERIES

- ✓ Full aluminium frame.
- ✓ 2 free pole umbrellas on one central pole.
- ✓ Heavy 300 kg steel base or in ground base.
- ✓ Ideal for project and terrace applications.
- ✓ Belgian design.



An umbrella that will grace every large terrace by its Belgian design as a true eye-catcher. Our JCP.601 combines two outdoor umbrellas of 300 x 300 cm that can be opened, closed and tilted in height independently. Together, they provide 18 m² of shade. Thanks to one pole, the space under the umbrellas can be used optimally which makes this sunshade ideal for catering projects. Six Series is available in three frame colours and two different canopy colours. Custom fabrics are always available on request.

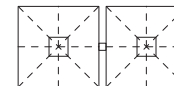

JCP.601
2* 300 x 300 cm

- FRAME** 2 free pole umbrellas with crank. Pole and ribs are aluminium powder coated.
Pole profile: 150 x 150 x 2,5 mm, 5,9 x 5,9 x 0,1".
Ribs profile: 32 x 32 x 2,5 mm, 1,2 x 1,2 x 0,1".
- CANOPY** 320g/m² Sunbrella® Plus, 100% solution dyed acrylic.
⌚ Fast stock: canopies available on stock.
- BASE** Hot galvanized and powder coated steel plates.
- TILT** Tilt in height.
- WIND SPEED** 58 km/h, 36 mph - Maximum wind speed to which the umbrella may be exposed.

jardinico®
CARACTÈRE

FRAME

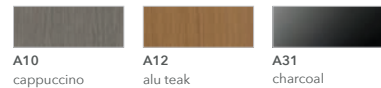

CANOPY

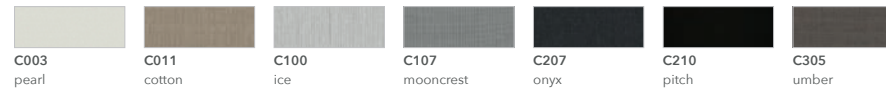

JCP.601 - 2* 300 x 300 cm	Weight net	Weight gross	Packaging CBM / CCF	Units
UMBRELLA FRAME & CANOPY	86.5 kg 190.7 lbs	93 kg 205.1 lbs	244 x 40 x 40 cm 96.1 x 15.7 x 15.7"	1
UFJCP.601 FRAME ONLY INCL. POLE FRAME, 2X UMBRELLA FRAME & PROTECTION COVER	83.5 kg 184.1 lbs	88.5 kg 195.2 lbs	244 x 40 x 40 cm 96.1 x 15.7 x 15.7"	3
UCJCP.601 CANOPY ONLY INCL. 2X CANOPIES	3 kg 6.6 lbs	4.5 kg 9.9 lbs	60 x 46 x 11 cm 23.6 x 18.1 x 4.3"	2
UBJCP.5S-6S BASE	300 kg 661 lbs	309 kg 681 lbs	120 x 120 x 10 cm 47.2 x 47.2 x 3.9"	1
UBIGB-JCP.4S-5S-6S IN GROUND BASE	8.5 kg 18.7 lbs	10 kg 22 lbs	27 x 64 x 27 cm 10.6 x 25.2 x 10.6"	1
UBOGB-JCP.4S-5S-6S ON GROUND BASE	6.5 kg 14.33 lbs	7 kg 15.4 lbs	27 x 27 x 6 cm 10.6 x 10.6 x 2.4"	1
UPJCP.5S-X77 PROTECTION COVER	0.8 kg 1.8 lbs	1 kg 2.2 lbs	17 x 48 x 4 cm 6.7 x 18.9 x 1.6"	1

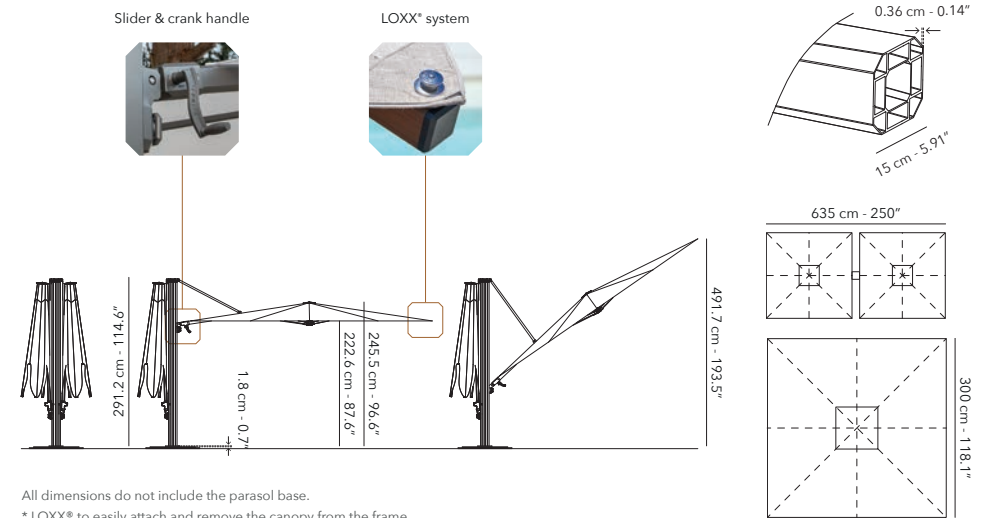

All dimensions do not include the parasol base.
* LOXX* to easily attach and remove the canopy from the frame.

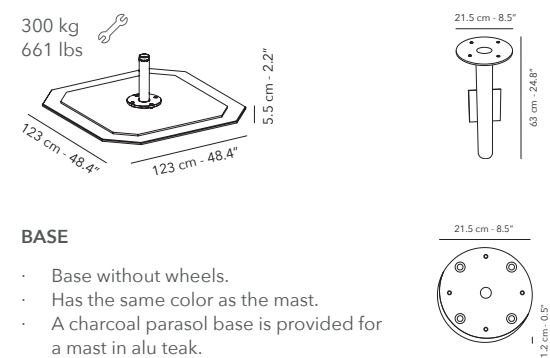

BASE

- Base without wheels.
- Has the same color as the mast.
- A charcoal parasol base is provided for a mast in alu teak.

IN GROUND BASE

Anchored in the ground with concrete.
Fixed and cannot be moved.

FLOOR FIXING PLATE

Anchored in the ground with concrete.
Fixed and cannot be moved.

To enhance the durability and appearance, we recommend following our care instructions regularly.

The umbrella should never be used in strong wind or rainy conditions. An open umbrella should never be left unattended. The umbrella should be protected against blurring or damage by using its protection cover. The protection cover can be placed over the umbrella and pole. Store the umbrella in a dry place when not in use.

FRAME & BASE

Clean the aluminium frame with a damp cloth, mild soap and water. Do not use any sharp tool to avoid scratches.

CANOPY



Before use, you can apply an invisible film to make the canopy stain and water repellent by using a textile protector. You can maintain and clean your canopy by following a few simple steps:

- Brush off loose dirt before it becomes embedded in the fabric.
- Hose down.
- Spot clean soon after stains occur with water and mild soap or a textile cleaner (no detergents). Use a soft bristle brush to clean.
- Allow soap to soak in.
- Rinse thoroughly.
- Always let the canopy air dry completely before storing or covering.

Machine wash in cold water. Depending on wash load size, use normal amounts of mild laundry detergent and add 1 cup of bleach. Allow fabric to air dry.

NEVER SUBJECT TO EXCESSIVE HEAT, STEAM PRESS OR TUBLE DRY AS THE FABRIC WILL SHRINK.



		Weight net	Weight gross	Packaging CBM / CCF	Units
	SPCOR-12ML CORRECTOR PEN A01 white, A03 linen, A31 charcoal or A32 black	48 g 0.11 lbs	53 g 0.12 lbs	3 x 7 x 3 cm 1.2 x 2.8 x 1.2"	1
	PT000388 FABRIC MAINTENANCE KIT Includes 2 scrubbing sets, 3 application cloths, textile protector 750 ml, textile cleaner 750 ml	1.7 kg 3.7 lbs	1.9 kg 4.2 lbs	21 x 28 x 10.5 cm 8.3 x 11 x 4.2"	1

MADE FOR **SHADE &
OUTDOOR LIVING.**

www.jardinico.com